

Solubility in the $\text{Na}_2\text{CO}_3 + \text{NaHCO}_3 + \text{Na}_2\text{SO}_4 + \text{NaCl} + \text{H}_2\text{O}$ System and Its Subsystems at 150 °C

Xiao-Sen Li*

Department of Chemical Engineering, Tsinghua University, Beijing 100084, China

Chen-Ding Zhang, Hui-Jie Wu, Jin-Rong Liu, and Tong Zhang

Department of Chemical Engineering, Inner Mongolia Polytechnic University, Huhehot 010062, China

An apparatus was developed to determine the solubility of salts in water at high temperatures. The phase equilibrium data for the ternary systems $\text{NaHCO}_3 + \text{NaCl} + \text{H}_2\text{O}$ and $\text{NaHCO}_3 + \text{Na}_2\text{SO}_4 + \text{H}_2\text{O}$, the quaternary systems $\text{Na}_2\text{CO}_3 + \text{NaHCO}_3 + \text{Na}_2\text{SO}_4 + \text{H}_2\text{O}$, $\text{Na}_2\text{CO}_3 + \text{NaHCO}_3 + \text{NaCl} + \text{H}_2\text{O}$, and $\text{NaHCO}_3 + \text{Na}_2\text{SO}_4 + \text{NaCl} + \text{H}_2\text{O}$, and the five-component system $\text{Na}_2\text{CO}_3 + \text{NaHCO}_3 + \text{Na}_2\text{SO}_4 + \text{NaCl} + \text{H}_2\text{O}$ at 150 °C were measured. Combined with the results of the previous investigations, the phase diagrams of these systems are plotted, and the analyses and discussions are made on the construction of the crystalline areas in these phase diagrams.

Introduction

The natural soda in the Inner Mongolia Autonomous Region of China mainly consists of sodium carbonate, sodium bicarbonate, sodium sulfate, and sodium chloride as well as minor amounts of potassium and lithium salts. Therefore, the natural soda solution in Inner Mongolia can be considered as the five-component system sodium carbonate + sodium bicarbonate + sodium sulfate + sodium chloride + water. In the technologic process of producing soda and Glauber's salt by means of vaporizing the natural soda solutions, the suitable amount of the evaporation of the soda solution needs to be controlled to achieve high-quality products and a high recovery percent of effective components. In addition, the order of salting out, the amount of water removed by the evaporation, and the separating-out amount of the solid phase are also some very important parameters in the process design control. The phase diagram for the system $\text{Na}_2\text{CO}_3 + \text{NaHCO}_3 + \text{Na}_2\text{SO}_4 + \text{NaCl} + \text{H}_2\text{O}$ at 150 °C is the important theoretical base of the determination of the parameters above.

Some studies have been done on the solubility for the subsystems of the five-component system $\text{Na}_2\text{CO}_3 + \text{NaHCO}_3 + \text{Na}_2\text{SO}_4 + \text{NaCl} + \text{H}_2\text{O}$ at 150 °C (Eddy and Menzies, 1940; Itkina and Kohova, 1955; Palkova and Ahumov, 1962; Schroeder et al., 1935, 1936; Stephen and Stephen, 1979; Waldeck et al., 1934; Zhang et al., 1991), but the studies of the phase equilibria for the ternary systems $\text{NaHCO}_3 + \text{NaCl} + \text{H}_2\text{O}$ and $\text{NaHCO}_3 + \text{Na}_2\text{SO}_4 + \text{H}_2\text{O}$, the quaternary systems $\text{Na}_2\text{CO}_3 + \text{NaHCO}_3 + \text{Na}_2\text{SO}_4 + \text{H}_2\text{O}$, $\text{Na}_2\text{CO}_3 + \text{NaHCO}_3 + \text{NaCl} + \text{H}_2\text{O}$, and $\text{NaHCO}_3 + \text{Na}_2\text{SO}_4 + \text{NaCl} + \text{H}_2\text{O}$, and the five-component system $\text{Na}_2\text{CO}_3 + \text{NaHCO}_3 + \text{Na}_2\text{SO}_4 + \text{NaCl} + \text{H}_2\text{O}$ at 150 °C have not been reported so far.

In this paper, the phase equilibria for the two ternary systems and three quaternary systems listed above are studied. The experimental results of $\text{Na}_2\text{CO}_3 + \text{NaHCO}_3 + \text{Na}_2\text{SO}_4 + \text{NaCl} + \text{H}_2\text{O}$ at 150 °C was also given.

Experimental Section

Experimental Apparatus. The experimental apparatus used in this work is composed of an equilibrium still, a thermostatic oil bath, a thermostatic controlling apparatus, and an agitating transmission apparatus. The equilibrium still is the main body of the apparatus and consists of the still body, the liquid sampler, the solid sample connection, and the gas vent. The volume of the still is 180 mL, and the volume of the liquid sampler is 18 mL. Figure 1 shows the structure sketch of the equilibrium still. The thermostatic controlling apparatus is an ERO temperature gauge equipped with a Pt-100 thermoprobe, which was calibrated against a Unomat TRX temperature calibrator. The accuracy of the temperature measurement is ± 0.05 °C. The heating medium in the thermostatic oil bath is JD-300 conducting heat oil. Using the methods of motor stirring and still agitation keeps temperature constant in the oil bath. The fluctuation range of the temperature in the oil bath is ± 0.14 °C.

Experimental Method. The system points are compounded by the drawing point method. For a ternary system, the system points are prepared by taking out some water and adding the second component gradually on the basis of the single salt saturation points. For a quaternary system, the system points are compounded by taking out some water and adding the third component gradually on the basis of the two salt cosaturation points. In the same way, for a five-component system, the system points are mixed by taking out some water and adding the fourth component gradually on the basis of the three salt cosaturation points. All the reagents used in the experiment are analytically pure, and water is distilled two times. The equilibrium is achieved by agitation for 24 h. After equilibrium, the system is allowed to rest for 30 min to separate the solid phase from the liquid phase. Then, the sample is taken out and given a quantitative analysis and identification. The content of the total soda is titrated with standard sulfuric acid solution using methyl orange solution as the indicator. The content of sodium bicarbonate is determined

* To whom correspondence should be addressed. E-mail: xsli@mail.cic.tsinghua.edu.cn.

Table 1. Characterization of Solid Phases

substance	color	appearance	refractive index			cryst syst
			N_g	N_m	N_p	
Na ₂ CO ₃	achromatic	stylotylitic	1.546	1.535	1.415	
Na ₂ SO ₄	achromatic or white	double pyramidal, short stylotylitic, or platelike	1.485	1.477	1.471	prismatic
NaHCO ₃	achromatic or white	stylotylitic or platelike	1.583	1.498	1.375	monoclinic
Na ₂ CO ₃ ·NaHCO ₃ ·2H ₂ O	achromatic or gray	stylotylitic or platelike	1.540	1.492	1.412	monoclinic
Na ₂ CO ₃ ·3NaHCO ₃	achromatic	fibrous, needlelike or platelike	1.528	1.519	1.433	triclinic
(Na ₂ SO ₄) ₂ ·Na ₂ CO ₃	achromatic	stylotylitic	1.493	1.489	1.448	prismatic
NaCl	achromatic,	cubic		1.544		equiaxial

Table 2. Comparison of Data of Phase Equilibria Measured and Literature Data at 150 °C

subject	fluid mass %			solid
	Na ₂ CO ₃	NaHCO ₃	H ₂ O	
measrd results	23.13	10.31	66.56	Na ₂ CO ₃ + Tr ^a
lit. data ^b	23.1	10.2	66.7	Na ₂ CO ₃ + Tr
rel err	0.03	0.11	-0.14	
abs err	0.13	1.08	-0.21	

^a Tr: Na₂CO₃·NaHCO₃·2H₂O. ^b Data source: Waldeck et al. (1934).

by excess alkalimetry using phenolphthalein solution as the indicator. The content of sodium sulfate is determined by gravimetric method, and the content of sodium chloride is determined by argentometry. The equilibrium solid phase is determined by crystal optical methods with China XPT-6 and Japan OPTIPHOT-POL polarizing microscope. In the process of the identification of the solid phases, first according to the optical properties of the crystals, the immersion method is used to compare the refractive indexes of the immersion oil with ones of the crystals for determining the values of the $N_g-N_p-N_m$ of the crystals. Then the appearances, extinction phenomena, interference colors, and interferograms of the crystals are observed. In this way, the solid phases can be identified. The characterizations of the solid phases observed are shown in Table 1.

To prevent the effect of the CO₂ in air, the samples are taken out in the nitrogen cabinet. During the experiments, the CO₂ forms and mainly escapes to the vapor phase from the liquid phase on account of the existence of carbonate and bicarbonate with slight solubility of the CO₂ in the liquid phase. By use of the ionization equilibrium constants and the Henry's constant of the CO₂, the partial pressures of the CO₂ in the equilibrium vapor phases can be obtained under different equilibrium concentrations in the liquid phases. From our calculation, in most cases, the ratios of the partial pressure of the CO₂ with the total pressure in the equilibrium vapor phase only are 0.09–0.25%. It shows that the contents of the CO₂ in the vapor phase are quite

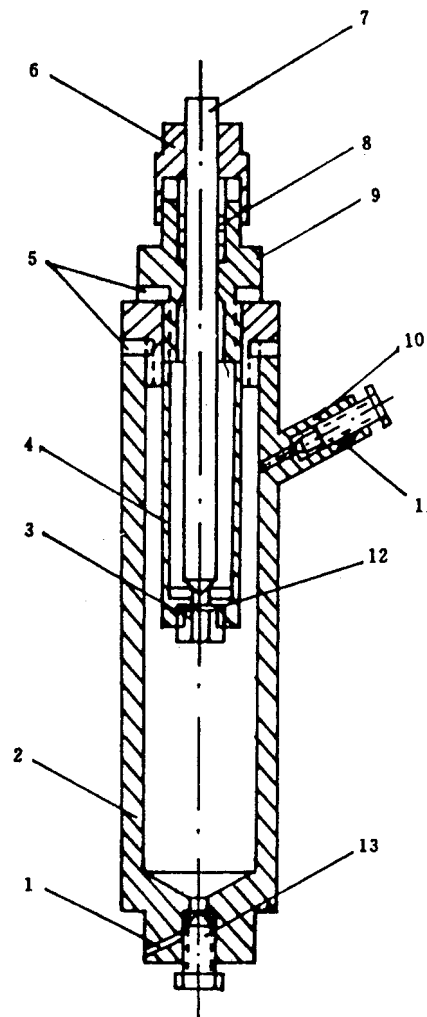
**Figure 1.** Structural sketch of equilibrium still: 1, solid sample connection; 2, still body; 3, filter screen fixer; 4, liquid sampler barrel; 5, gasket; 6, gland nut; 7, valve stem; 8, throat ring; 9, coupling head; 10, gas vent; 11, vent sealing screw; 12, filter screen; 13, still bottom sealing screw.**Table 3. Repeatability of Data of Phase Equilibria Measured**

no.	fluid mass %					solid
	Na ₂ CO ₃	NaHCO ₃	Na ₂ SO ₄	NaCl	H ₂ O	
1	—	19.20	17.89	—	62.91	NaHCO ₃ + Na ₂ SO ₄
	—	19.21	17.86	—	62.93	
2	—	11.01	—	24.30	64.69	NaHCO ₃ + NaCl
	—	11.04	—	24.28	64.68	
3	—	9.37	4.98	23.41	62.24	NaHCO ₃ + Na ₂ SO ₄ + NaCl
	—	9.35	4.95	23.42	62.28	
4	19.69	13.90	2.84	—	63.57	Na ₂ CO ₃ + <i>m</i> Na ₂ SO ₄ · <i>n</i> Na ₂ CO ₃ + Na ₂ CO ₃ ·NaHCO ₃ ·2H ₂ O
	19.67	13.89	2.85	—	63.59	
5	13.27	10.32	—	9.61	66.80	Na ₂ CO ₃ + Na ₂ CO ₃ ·NaHCO ₃ ·2H ₂ O + NaCl
	13.26	10.34	—	9.59	66.81	
6	1.27	10.86	2.48	23.66	61.73	NaCl + <i>m</i> Na ₂ SO ₄ · <i>n</i> Na ₂ CO ₃ + (Na ₂ CO ₃) ₃ ·NaHCO ₃ + NaHCO ₃
	1.29	10.85	2.45	23.67	61.74	

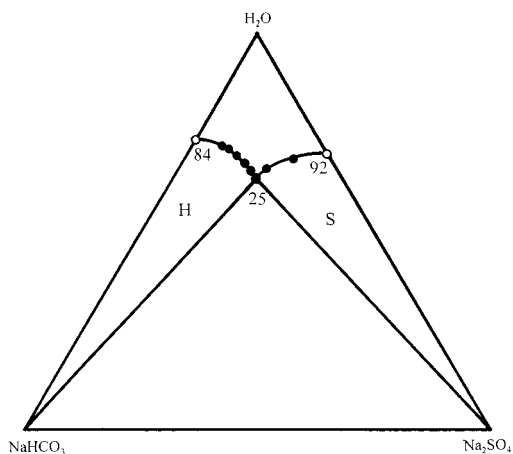

Figure 2. Phase diagram of the ternary system $\text{NaHCO}_3 + \text{Na}_2\text{SO}_4 + \text{H}_2\text{O}$ at $150\text{ }^\circ\text{C}$: (●) measured solubility data; (○) literature data; (—) solubility curve; H, NaHCO_3 crystallization zone; S, Na_2SO_4 crystallization zone.

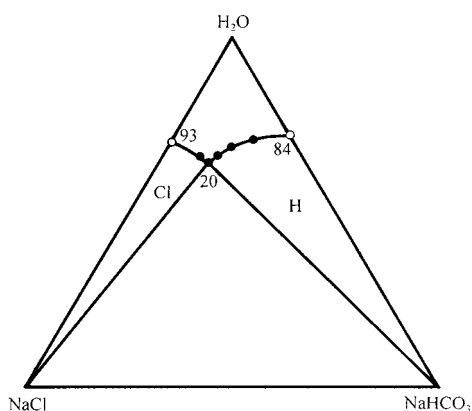

Figure 3. Phase diagram of the ternary system $\text{NaHCO}_3 + \text{NaCl} + \text{H}_2\text{O}$ at $150\text{ }^\circ\text{C}$: (●) measured solubility data; (○) literature data; (—) solubility curve; H, NaHCO_3 crystallization zone; Cl, NaCl crystallization zone.

small. In addition, the experimental systems are the sealed ones, and the volumes of the vapor phases are much smaller, compared with ones of the liquid and solid phases. Accordingly, the formation of CO_2 has almost no effect on the equilibrium fluid composition.

To prove the reliability of the experimental apparatus and method utilized in this paper, before the formal experiment, we measure the data of one cosaturation point of the system $\text{Na}_2\text{CO}_3 + \text{NaHCO}_3 + \text{H}_2\text{O}$ with the experimental apparatus developed. The results (shown in Table 2) are in good accordance with the data of the literature (Waldeck et al., 1934). The experimental results of the repeatability shown in Table 3 test that the phase equilibrium data measured by the apparatus in the paper have good repeatability.

Results and Discussion

Ternary System $\text{NaHCO}_3 + \text{Na}_2\text{SO}_4 + \text{H}_2\text{O}$ at $150\text{ }^\circ\text{C}$. Eight groups of data for the three-component system $\text{NaHCO}_3 + \text{Na}_2\text{SO}_4 + \text{H}_2\text{O}$ at $150\text{ }^\circ\text{C}$ are measured, and the results are shown in Table 4. Combined with two groups of data of the previous investigations, the phase diagram of the system is plotted, shown as Figure 2. The system has two single salt crystallization zones, the sodium bicarbonate crystallization zone and the sodium sulfate crystallization zone. The latter is slightly larger than the former. The cosaturation point of sodium bicar-

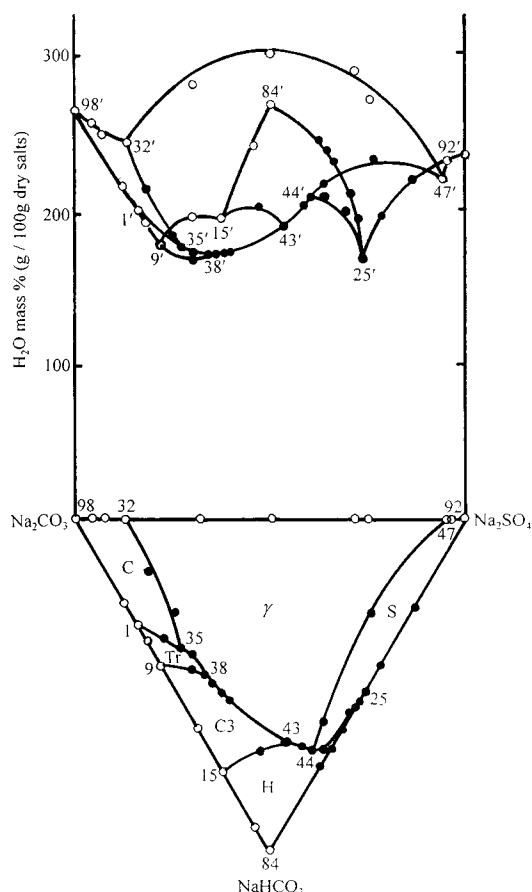

Figure 4. Dry salt and water diagrams of the quaternary system $\text{Na}_2\text{CO}_3 + \text{NaHCO}_3 + \text{Na}_2\text{SO}_4 + \text{H}_2\text{O}$ at $150\text{ }^\circ\text{C}$: (●) measured solubility data; (○) literature data; (—) solubility curve; C, Na_2CO_3 crystallization zone; γ , $m\text{Na}_2\text{SO}_4 \cdot n\text{Na}_2\text{CO}_3$ crystallization zone; S, Na_2SO_4 crystallization zone; H, NaHCO_3 crystallization zone; C3, $(\text{NaHCO}_3)_3 \cdot \text{Na}_2\text{CO}_3$ crystallization zone; Tr, $\text{Na}_2\text{CO}_3 \cdot \text{NaHCO}_3 \cdot 2\text{H}_2\text{O}$ crystallization zone.

bonate and sodium sulfate is a symmetrical zero changing point.

Ternary System $\text{NaHCO}_3 + \text{NaCl} + \text{H}_2\text{O}$ at $150\text{ }^\circ\text{C}$. Five groups of data for the ternary system $\text{NaHCO}_3 + \text{NaCl} + \text{H}_2\text{O}$ at $150\text{ }^\circ\text{C}$ are measured, and the results are shown in Table 4. Combined with two groups of the literature data, the phase diagram of the system is plotted, shown in Figure 3. The system has two single salt crystallization zones, a sodium bicarbonate crystallization zone and a sodium chloride crystallization zone, which is smaller than the former. The cosaturation point of sodium bicarbonate and sodium chloride is a symmetrical zero changing point.

Quaternary System $\text{Na}_2\text{CO}_3 + \text{NaHCO}_3 + \text{Na}_2\text{SO}_4 + \text{H}_2\text{O}$ at $150\text{ }^\circ\text{C}$. Eighteen groups of data for the quaternary system $\text{Na}_2\text{CO}_3 + \text{NaHCO}_3 + \text{Na}_2\text{SO}_4 + \text{H}_2\text{O}$ at $150\text{ }^\circ\text{C}$ are measured, and the results are shown in Table 4. Combined with twenty-eight groups of data that the previous investigators gave, the dry salt and water diagram of the system are plotted, shown in Figure 4. The diagram of the system includes four three-salt cosaturation points and six crystallization zones in which there are three single salt crystallization zones, i.e., sodium carbonate, sodium bicarbonate, and sodium sulfate crystallization zones, two double-salt crystallization zones, i.e., sesquisalt ($\text{Na}_2\text{CO}_3 \cdot \text{NaHCO}_3 \cdot 2\text{H}_2\text{O}$) and Wegscheider double-salt ($3\text{NaHCO}_3 \cdot \text{Na}_2\text{CO}_3$) crystallization zones, and one solid solution crystallization zone, i.e., the γ salt ($m\text{Na}_2\text{SO}_4 \cdot n\text{Na}_2\text{CO}_3$) crystallization zone. In the diagram, the γ salt

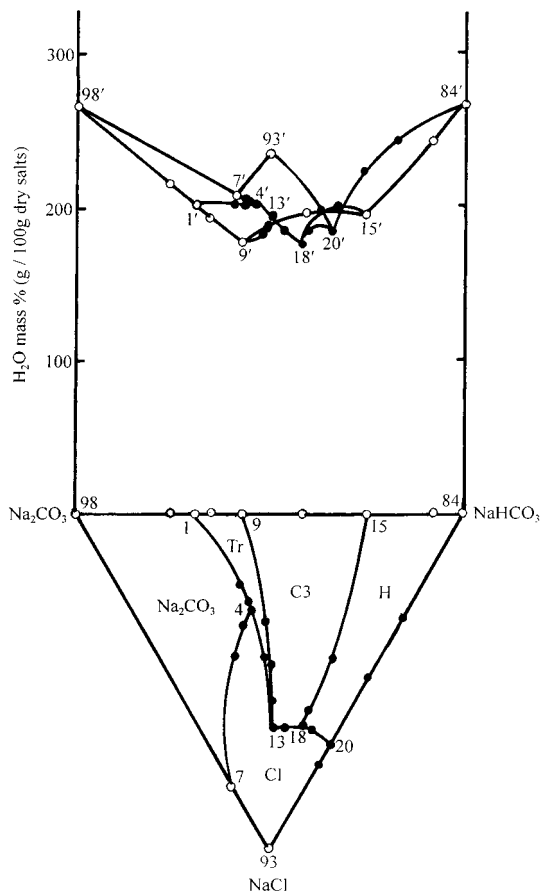

Figure 5. Dry salt and water diagrams of the quaternary system $\text{Na}_2\text{CO}_3 + \text{NaHCO}_3 + \text{NaCl} + \text{H}_2\text{O}$ at $150\text{ }^\circ\text{C}$: (●) measured solubility data; (○) literature data; (—) solubility curve; C, Na_2CO_3 crystallization zone; Tr, $\text{Na}_2\text{CO}_3 \cdot \text{NaHCO}_3 \cdot 2\text{H}_2\text{O}$ crystallization zone; C3, $(\text{NaHCO}_3)_3 \cdot \text{Na}_2\text{CO}_3$ crystallization zone; H, NaHCO_3 crystallization zone; Cl: NaCl crystallization zone.

crystallization zone is the largest, and the sesquisalt crystallization zone is the smallest.

Quaternary System $\text{Na}_2\text{CO}_3 + \text{NaHCO}_3 + \text{NaCl} + \text{H}_2\text{O}$ at $150\text{ }^\circ\text{C}$. Fifteen groups of data for the quaternary system $\text{Na}_2\text{CO}_3 + \text{NaHCO}_3 + \text{NaCl} + \text{H}_2\text{O}$ at $150\text{ }^\circ\text{C}$ are measured, and the results are shown in Table 4. Combined with sixteen groups of the literature data, the dry salt and water diagrams of the system are plotted, shown in Figure 5. The system includes five crystallization zones, sodium carbonate, sodium bicarbonate, sodium chloride, sesquisalt, and Wegscheider double-salt crystallization zones, in which Wegscheider double-salt and sodium carbonate crystallization zones are larger and the sesquisalt crystallization zone is smaller. All three three-salt cosaturation points for the four-component system at $150\text{ }^\circ\text{C}$ are the symmetrical zero changing points.

Quaternary System $\text{NaHCO}_3 + \text{Na}_2\text{SO}_4 + \text{NaCl} + \text{H}_2\text{O}$ at $150\text{ }^\circ\text{C}$. Nineteen groups of data for the quaternary system $\text{Na}_2\text{CO}_3 + \text{Na}_2\text{SO}_4 + \text{NaCl} + \text{H}_2\text{O}$ at $150\text{ }^\circ\text{C}$ are measured, and the results are shown in Table 4. In combination with the data that the previous investigators gave, the dry salt and water diagrams of the system are plotted, shown in Figure 6. In the crystallization zones of the system, including sodium bicarbonate, sodium sulfate, and sodium chloride crystallization zones, the sodium sulfate crystallization zone is the largest and the sodium chloride crystallization zone is the smallest. The three-salt cosaturation points for the four-component system at $150\text{ }^\circ\text{C}$ are the symmetrical zero changing points.

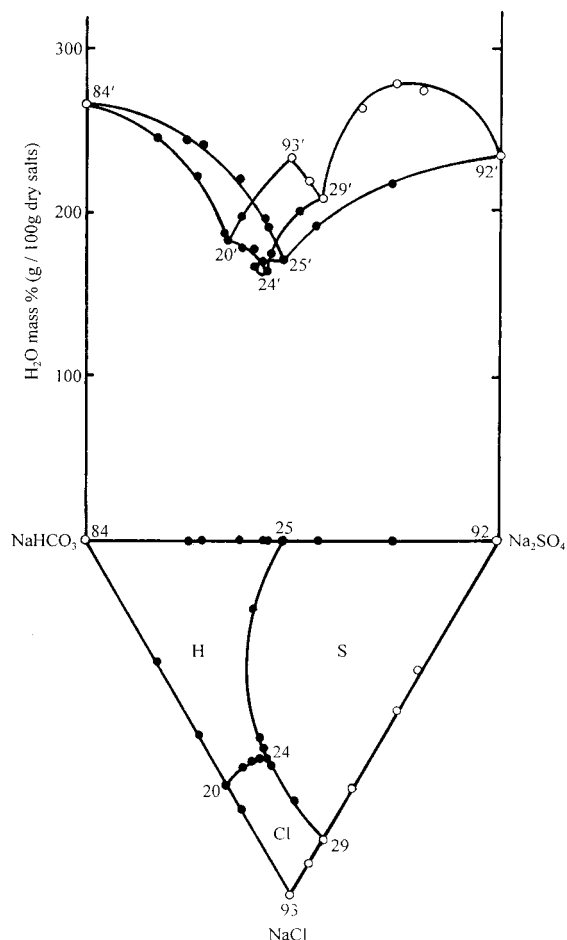

Figure 6. Dry salt and water diagrams of the quaternary system $\text{NaHCO}_3 + \text{Na}_2\text{SO}_4 + \text{NaCl} + \text{H}_2\text{O}$ at $150\text{ }^\circ\text{C}$: (●) measured solubility data; (○) literature data; (—) solubility curve; H, NaHCO_3 crystallization zone; S, Na_2SO_4 crystallization zone; Cl, NaCl crystallization zone.

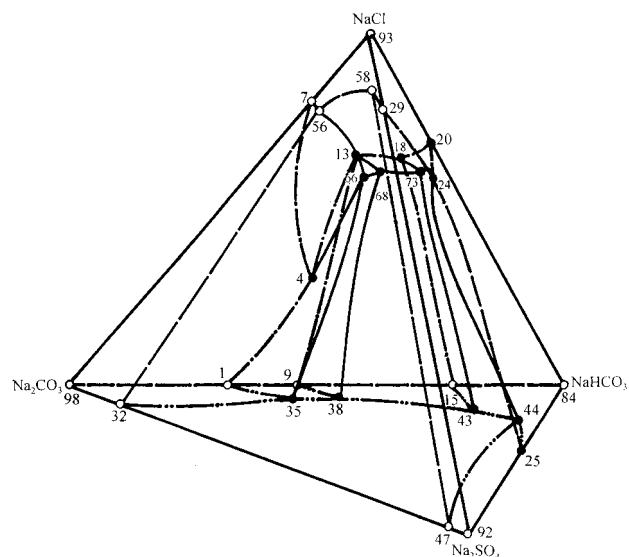

Figure 7. Three-dimensional dry salt diagram of the five-component system $\text{Na}_2\text{CO}_3 + \text{NaHCO}_3 + \text{Na}_2\text{SO}_4 + \text{NaCl} + \text{H}_2\text{O}$ at $150\text{ }^\circ\text{C}$: (●) measured solubility data; (○) literature data; (—) solubility curves of the five-component system; (---) solubility curves of its subsystems.

Five-Component System $\text{Na}_2\text{CO}_3 + \text{NaHCO}_3 + \text{Na}_2\text{SO}_4 + \text{NaCl} + \text{H}_2\text{O}$ at $150\text{ }^\circ\text{C}$. Nineteen groups of phase equilibrium data for the five-component system $\text{Na}_2\text{CO}_3 +$

Table 4. Data of Phase Equilibria for the Five-Component System Na₂CO₃ + NaHCO₃ + Na₂SO₄ + NaCl + H₂O at 150 °C

no.	liquid mass %					dry salt (liquid) mass %				H ₂ O mass % ^a	solid	ref ^b
	Na ₂ CO ₃	NaHCO ₃	Na ₂ SO ₄	NaCl	H ₂ O	Na ₂ CO ₃	NaHCO ₃	Na ₂ SO ₄	NaCl			
1	23.10	10.20			66.70	69.37	30.63			200.30	C ^c + Tr ^d	(1)
2	15.42	10.44		7.34	66.80	46.45	31.45		22.10	201.20	C + Tr	
3	14.10	10.55		8.72	66.63	42.25	31.62		26.13	199.67	C + Tr	
4	13.27	10.32		9.61	66.80	39.97	31.08		28.95	201.20	C + Tr + Cl ^e	
5	13.23	8.80		10.93	67.04	40.14	26.70		33.16	203.40	C + Cl	
6	12.32	6.57		13.95	67.16	37.52	20.01		42.47	204.51	C + Cl	
7	5.84			26.80	67.36	17.89			82.11	206.37	C + Cl	(2)
8	10.10	8.89		14.42	66.59	30.23	26.61		43.16	199.31	Tr + Cl	
9	20.70	15.40			63.90	57.34	42.66			177.01	C3 ^f + Tr	(1)
10	12.27	11.45		11.34	64.94	35.00	32.66		32.34	185.23	C3 + Tr	
11	9.59	9.55		15.75	65.11	27.49	27.37		45.14	186.62	C3 + Tr	
12	7.52	7.79		19.56	65.13	21.57	22.34		56.09	186.78	C3 + Tr	
13	5.88	6.24		21.88	66.00	17.29	18.35		64.36	194.12	C3 + Tr + Cl	
14	5.27	7.51		22.41	64.81	14.98	21.34		63.68	184.17	C3 + Cl	
15	8.40	25.60			66.00	24.71	75.29			194.12	C3 + H ^g	(1)
16	3.76	14.82		14.55	66.87	11.35	44.73		43.92	201.84	C3 + H	
17	3.76	10.35		19.84	66.05	11.08	30.49		58.43	194.55	C3 + H	
18	3.63	9.60		23.33	63.44	9.93	26.26		63.81	173.52	C3 + H + Cl	
19	3.23	9.76		22.12	64.89	9.20	27.80		63.00	184.82	H + Cl	
20		11.01		24.30	64.69		31.18		68.82	183.21	H + Cl	
21		10.65	2.18	23.04	64.13		29.69	6.08	64.23	178.78	H + Cl	
22		10.15	3.24	22.44	64.17		28.33	9.04	62.63	179.10	H + Cl	
23		9.83	4.53	22.86	62.78		26.41	12.17	61.42	168.67	H + Cl	
24		9.37	4.98	23.41	62.24		24.81	13.19	62.00	164.83	H + Cl + S ^h	
25		19.20	17.89		62.91		51.77	48.23		169.61	H + S	
26		18.63	11.59	7.23	62.55		49.75	30.94	19.31	167.02	H + S	
27		10.34	5.02	21.89	62.75		27.76	13.48	58.76	168.46	H + S	
28		10.00	5.14	22.44	62.42		26.61	13.68	59.71	166.10	H + S	
29			5.00	27.50	67.50			15.38	84.62	207.69	Cl + S	(3)
30		3.83	4.97	24.39	66.81		11.54	14.97	73.49	201.30	Cl + S	
31		8.62	4.82	22.84	63.72		23.76	13.29	62.95	175.63	Cl + S	
32	25.40		3.80		70.80	86.99		13.01		242.47	C + r	
33	23.83	4.85	3.23		68.09	74.68	15.20	10.12		213.38	C + r	
34	21.76	9.80	4.24		64.20	60.78	27.37	11.85		179.33	C + r ⁱ	
35	19.69	13.90	2.84		63.57	54.05	38.16	7.79		174.50	C + r + Tr	
36	21.05	12.28	1.74		64.93	60.02	35.02	4.96		185.14	C + Tr	
37	18.93	14.78	3.52		62.77	50.85	39.70	9.45		168.60	Tr + r	
38	15.82	17.20	3.71		63.27	43.07	46.83	10.10		172.26	Tr + r + C3	
39	17.93	16.99	2.72		62.36	47.64	45.14	7.22		165.67	Tr + C3	
40	15.15	18.14	3.73		62.98	40.92	49.00	10.08		170.12	C3 + r	
41	13.16	18.86	4.58		63.40	35.96	51.53	12.51		173.22	C3 + r	
42	12.92	19.56	4.72		62.80	34.73	52.58	12.69		168.82	C3 + r	
43	4.53	22.94	7.14		65.39	13.09	66.28	20.63		188.93	C3 + r + H	
44	1.68	22.60	8.32		67.40	5.15	69.33	25.52		206.75	H + r + S	
45	0.14	22.02	14.42		63.42	0.38	60.20	39.42		173.37	H + S	
46	0.33	22.40	10.17		67.10	1.00	68.09	30.91		203.95	H + S	
47	1.70		29.70		68.60	5.41		94.59		218.47	S + r	(4)
48	3.08	8.21	18.65		70.06	10.29	27.42	62.29		234.00	S + r	
49	2.09	19.44	10.89		67.58	6.45	59.96	33.59		208.45	S + r	
50	6.08	22.81	4.18		66.93	18.39	68.97	12.64		202.39	C3 + H	
51	2.36	22.93	8.05		66.66	7.08	68.78	24.14		199.94	H + r	
52	17.55		2.77	7.16	72.52	63.86		10.08	26.06	263.90	C + r	(2)
53	14.44		2.03	11.08	72.45	52.41		7.37	40.22	262.98	C + r	(2)
54	11.60		1.65	14.84	71.91	41.30		5.87	52.83	256.00	C + r	(2)
55	9.09		1.52	18.68	70.71	31.03		5.19	63.78	241.41	C + r	(2)
56	6.09		0.92	25.46	67.53	18.76		2.83	78.41	207.98	C + r + Cl	(2)
57	3.46		1.54	27.39	67.61	10.68		4.76	84.56	208.74	Cl + r	(2)
58	0.71		3.29	28.51	67.49	2.18		10.12	87.70	207.60	Cl + r + S	(2)
59	0.64		3.59	27.82	67.95	2.00		11.20	86.80	212.01	S + r	(2)
60	0.84		10.83	15.70	72.63	3.07		39.57	57.36	265.36	S + r	(2)
61	0.97		13.28	12.63	73.12	3.61		49.40	46.99	272.02	S + r	(2)
62	1.35		18.04	7.51	73.10	5.02		67.06	27.92	271.75	S + r	(2)
63	15.11	11.63	1.62	6.61	65.03	43.21	33.26	4.63	18.90	185.96	C + H + r	
64	6.76	8.21	1.22	18.70	65.11	19.38	23.53	3.50	53.59	186.62	C + H + r	
65	5.13	7.67	1.14	20.67	65.39	14.82	22.16	3.29	59.73	188.93	C + H + r	
66	5.40	7.28	1.06	23.06	63.20	14.67	19.78	2.88	62.67	171.74	C + H + r + Cl	
67	4.80	7.51	1.03	21.10	65.56	13.94	21.81	2.99	61.26	190.36	Cl + r + C3	
68	4.63	8.07	1.60	22.18	63.52	12.69	22.12	4.39	60.80	174.12	Tr + C3 + r + Cl	
69	5.28	7.46	0.46	23.83	62.97	14.26	20.15	1.24	64.35	170.05	Tr + C3 + Cl	
70	7.42	8.03	2.84	14.13	67.58	22.89	24.77	8.76	43.58	208.45	Tr + C3 + r	
71	5.36	7.74	1.64	21.08	64.18	14.96	21.61	4.58	58.85	179.17	Tr + C3 + r	
72	2.55	9.69	2.33	22.73	62.70	6.84	25.98	6.25	60.93	168.10	C3 + Cl + r	
73	1.27	10.86	2.48	23.66	61.73	3.32	28.38	6.48	61.82	161.30	C3 + Cl + r + H	
74	3.92	18.36	5.81	6.64	65.27	11.29	52.86	16.73	19.12	187.94	C3 + r + H	
75	2.61	12.61	3.38	16.22	65.18	7.50	36.21	9.71	46.58	187.19	C3 + r + H	

Table 4 (Continued)

no.	liquid mass %					dry salt (liquid) mass %				H ₂ O mass % ^a	solid ^b	ref ^c
	Na ₂ CO ₃	NaHCO ₃	Na ₂ SO ₄	NaCl	H ₂ O	Na ₂ CO ₃	NaHCO ₃	Na ₂ SO ₄	NaCl			
76	1.47	11.37	2.73	21.08	62.63	3.93	30.43	7.31	58.33	167.59	C3 + r + H	
77	1.79	19.55	7.65	5.08	65.93	5.25	57.38	22.45	14.92	193.51	S + r + H	
78	1.85	13.33	5.09	14.38	65.35	5.34	38.47	14.69	41.50	188.60	S + r + H	
79	1.46	12.56	3.92	18.63	63.43	3.99	34.35	10.72	50.94	173.45	S + r + H	
80	0.72	10.97	3.20	23.05	62.06	1.90	28.91	8.43	60.76	163.57	S + r + H + Cl	
81	0.87	9.83	2.69	22.26	64.35	2.44	27.57	7.55	62.44	180.50	Cl + r + H	
82	2.10	9.80	1.50	23.35	63.25	5.71	26.67	4.08	63.54	172.11	C + Cl + H	
83	5.09	4.26	1.21	27.38	62.06	13.42	11.23	3.19	72.16	163.57	C + Cl + r	
84		27.20			72.80		100.00			267.65	H	(5)
85		22.02	6.97		71.01		75.96	24.04		244.95	H	
86		20.89	8.26		70.85		71.66	28.34		243.05	H	
87		19.45	11.71		68.84		62.42	37.58		220.92	H	
88		19.10	14.72		66.18		56.48	43.52		195.68	H	
89		19.00	15.40		65.60		55.23	44.77		190.70	H	
90		15.15	19.01		65.84		44.35	55.65		192.74	S	
91		8.18	23.31		68.51		25.98	74.02		217.56	S	
92			29.63		70.37			100.00		237.50	S	
93				29.88	70.12				100.0	234.67	Cl	(3)
94		8.49		25.06	66.45		25.31		74.69	198.06	Cl	
95		11.88		22.96	65.16		34.10		65.90	187.03	H	
96		14.70		16.30	69.00		47.42		52.58	222.58	H	
97		18.90		10.01	71.09		65.38		34.62	245.90	H	
98	27.50				72.50	100.00				263.64	C	(1)
99	24.40	7.40			68.20	76.73	23.27			214.47	C	(1)
100	22.40	11.90			65.70	65.31	34.69			191.55	Tr	(1)
101	13.80	20.00			66.20	40.83	59.17			195.86	C3	(1)
102	2.50	26.80			70.70	8.53	91.47			241.30	H	(1)
103	1.30		28.90		69.80	4.30		95.70		231.13	S	(4)
104	1.70		28.90		69.40	5.56		94.44		226.80	S	(4)
105	6.90		20.40		72.70	25.27		74.73		266.30	r	(4)
106	7.30		18.40		74.30	28.40		71.60		289.11	r	(4)
107	12.50		12.50		75.00	50.00		50.00		300.00	r	(4)
108	18.60		8.10		73.30	69.66		30.34		274.53	r	(4)
109	26.90		1.90		71.20	93.40		6.60		247.22	C	(4)
110	27.00		1.10		71.90	96.09		3.91		255.87	C	(4)
111			29.70		70.30			100.00		236.70	S	(6)
112			19.98	6.66	73.36			75.00	25.00	275.38	S	(3)
113			13.15	13.15	73.70			50.00	50.00	280.23	S	(3)
114			9.16	18.32	72.52			33.33	66.67	263.90	S	(3)
115			2.85	28.50	68.65			9.09	90.91	218.98	Cl	(3)

^a Water mass percent based on dry salts. ^b C, Na₂CO₃; Tr, Na₂CO₃·NaHCO₃·2H₂O; Cl, NaCl; C3, (NaHCO₃)₃·Na₂CO₃; H, NaHCO₃; S, Na₂SO₄; r, mNa₂SO₄·nNa₂CO₃. ^c The places not marked in the column are the data measured in this paper; (1)–(6) in the column are the literature data coming from Waldeck et al. (1934), Zhang et al. (1991), Palkova and Ahumov (1962), Itkina and Kohova (1955), Stephen and Stephen (1979), and Eddy and Menzies (1940), respectively.

NaHCO₃ + Na₂SO₄ + NaCl + H₂O at 150 °C are measured, and the results are shown in Table 4. Combined with the solubility data of its subsystems measured in this paper and given from the literature, the three-dimensional dry salt diagram of the system is plotted, as shown in Figure 7. In Figure 7, the solubility curves of the system is subscribed as the real curves, and other curves are the solubility curves of its subsystems. The five-component system consists of seven crystallization bodies, i.e., Na₂CO₃, NaHCO₃, Na₂SO₄, NaCl, γ salt, sesquisalt, and Wegscheider double-salt crystallization bodies, in which sesquisalt and NaCl crystallization bodies are smaller and γ salt crystallization body, near the others, is the largest.

Conclusion

On the background of determining the suitable amount of the evaporation for producing sodium carbonate and Glauber's salt by means of vaporizing the natural soda solutions in Inner Mongolia, the phase equilibria for the five-component system Na₂CO₃ + NaHCO₃ + Na₂SO₄ + NaCl + H₂O and its subsystems, the ternary systems NaHCO₃ + NaCl + H₂O and NaHCO₃ + Na₂SO₄ + H₂O,

and the quaternary systems Na₂CO₃ + NaHCO₃ + Na₂SO₄ + H₂O, Na₂CO₃ + NaHCO₃ + NaCl + H₂O, and NaHCO₃ + Na₂SO₄ + NaCl + H₂O at 150 °C are studied in this paper. According to the solubility data measured and ones of the literature, the phase diagrams of these systems are plotted, and the analyses and discussions are made on the construction of these phase diagrams.

The studies in the paper lay a foundation for the analysis and calculation of the diagram for the vaporizing process for the five-component system Na₂CO₃ + NaHCO₃ + Na₂SO₄ + NaCl + H₂O at 150 °C.

Literature Cited

- Eddy, R. D.; Menzies, A. W. The Solubility of Certain Inorganic Compounds in Ordinary Water and in Deuterium Water. *J. Phys. Chem.* **1940**, *44*, 207–235.
- Itkina, L. S.; Kohova, V. F. *J. Siberian Branch Russ. Acad. Sci.: Phys. Chem. (in Russian)* **1955**, *26*, 242–247.
- Palkova, Y. V.; Ahumov, Y. U. *J. Inorg. Chem. (in Russian)* **1962**, *7*, 200–206.
- Schroeder, W. C.; Gabriel, A.; Partridge, E. P. Solubility Equilibria of Sodium Sulfate at Temperatures of 150 to 350 °C. I. Effect of Sodium Hydroxide and Sodium Chloride. *J. Am. Chem. Soc.* **1935**, *57*, 1539–1546.

- Schroeder, W. C.; Berk, A. A.; Gabriel, A. Solubility Equilibria of Sodium Sulfate at Temperatures of 150 to 350 °C. II. Effect of Sodium Hydroxide and Sodium Carbonate. *J. Am. Chem. Soc.* **1936**, 58, 843–849.
- Stephen, H.; Stephen, T. *Solubility of Inorganic and Organic Compounds*; Pergamon: Oxford, U.K., 1979; Vol. 3.
- Waldeck, W. F.; Lynn, G.; Hill, A. E. Aqueous Solubility of Salts at High Temperatures. II. The Ternary System Na_2CO_3 – NaHCO_3 – H_2O from 100 to 200 °C. *J. Am. Chem. Soc.* **1934**, 56, 43–47.

Zhang, C.-D.; Li, G.-S.; Liu, J.-R.; Wang, H. W.; Zhang, T. Study on the NaOH – Na_2CO_3 – Na_2SO_4 – NaCl – H_2O System at 150 °C. *Soda Ind. China (China)* **1991**, 2, 1–8.

Received for review October 19, 1998. Accepted April 6, 1999.

JE9802569